

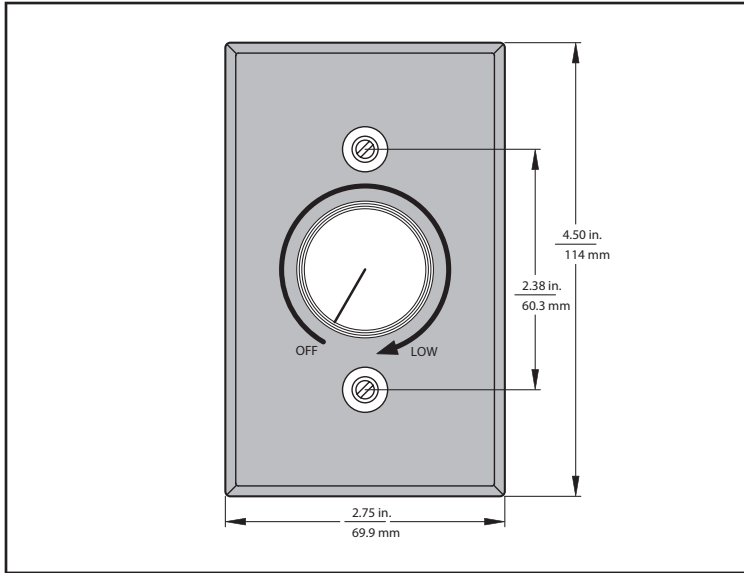

TRIAC-230-8 SPEED CONTROL SUBMITTAL

FOR CONTROL OF SINGLE OR MULTIPLE FANS

MODEL	VOLTAGE	AMPS	FAN QUANTITY ON DEDICATED CIRCUIT					
			MODEL 10	MODEL 15	MODEL 25	MODEL 45-PSP4	MODEL 45-PSP2	MODEL 60-PSP4
TRIAC-230-8	230V	8	131	113	56	39	10	11



TRIAC SPEED CONTROL DESCRIPTION

Airius speed controls are used to vary the speed of shaded pole or permanent split capacitor (PSC) motors (Air Pear or Designer Series 10, 15, 25, 45-P4, 45-P2, or 60-P4). Speed controls for EC motors: refer to the potentiometer submittal. Speed control for EL fans: refer to the FanCenter submittal.

ATTRIBUTES AND CHARACTERISTICS

- Built-in On/Off AC line switch
- Minimum speed trimpot
- RFI filter (provides RFI and EMI suppression)
- All models mount in a standard 2" x 4" electrical wall box
- Faceplate (4.5" x 2.75"), knob, screws and wire nuts included
- Simple installation by a qualified electrician
- Adjust top 50% RPM
- Can control multiple fans on a single dedicated circuit

PROJECT	
ENGINEER	
ARCHITECT	
CONTRACTOR	
SUBMITTED BY	
DATE	
QUANTITY	

CODE APPROVAL

- UL listing/recognition
- CSA certified

WARRANTY

- Warranty - 1 - years parts and workmanship

PART NUMBER & QUANTITY

TRIAC-230-8 Qty. _____

